





ST 91 PACKED PROFİL LİSTESİ
ST 91 PACKED PROFILE INDEX

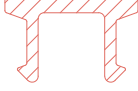
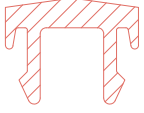
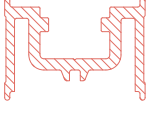

PROFİL NUM. PROFILE NO.	TANIM DESCRIPTION	ÇİZİM DRAWING	SAYFA PAGE
PRF-12025/ 12026	KASA PROFİLİ FRAME PROFILE		9
PRF-P 1300	DÜŞEY KANAT PROFİLİ VERTICAL SASH PROFILE		9
PRF-1302	YATAY KANAT PROFİLİ HORIZONTAL SASH PROFILE		9
PRF-12028	KASA ORTA KAYIT PROFİLİ MULLION PROFILE		10
PRF-12032	KENET KAPAMA PROFİLİ INTERLOCK CLOSING PROFILE		10
PRF-12030	DİŞLİ KENET PROFİLİ INTERLOCK PROFILE		10
PRF-P 12029	TAKVİYELİ KENET PROFİLİ INTERLOCK PROFILE WITH REINFORCEMENT		10
PRF-P 1314	ÇİFT KANAT ADAPTÖR PROFİLİ ADAPTER PROFILE FOR SASH		10
PRF-12033	DÜŞEY PERVAZ TUTUCU PROFİLİ VERTICAL ARCHITRAVE PROFILE		11
PRF-12031	YATAY PERVAZ PROFİLİ ARCHITRAVE PROFILE		11
PRF-12042	DÜŞEY PERVAZ PROFİLİ VERTICAL ARCHITRAVE PROFILE		11
PRF-ST P 1031	ORTA BİRLEŞİM İÇİN DÜŞEY KANAT PROFİLİ VERTICAL SASH PROFILE FOR MIDDLE		11

SARAY®

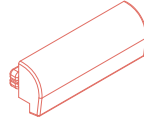
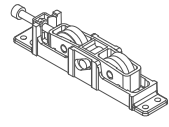
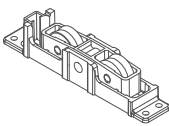
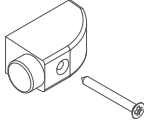
**ST 91 PACKED
CONTA VE AKSESUARLAR**

**ST 91 PACKED
GASKET AND ACCESSORIES**

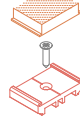
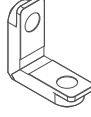
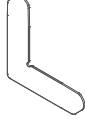
AKSESUAR KODU ACCESSORY CODE	MALZEME TANIMI DESCRIPTION	ÇİZİM DRAWING	MALZEME MATERIAL
600 424	KANAL KAPATMA PROFİLİ / CHANNEL CLOSING PROFILE KOLİ MİKTARI / PACKAGE QUANTITY: 6 mt 25 ad/pk		PVC
600 425	RAY PROFİLİ / RAIL PROFILE KOLİ MİKTARI / PACKAGE QUANTITY: 6 mt 25 ad/pk		POLİAMİD POLYAMİDE
600 421	PVC İSPANYOLET KANAL PROFİLİ / PVC CREMONE CHANNEL KOLİ MİKTARI / PACKAGE QUANTITY: 6 mt 25 ad/pk		PVC
700 468	KENET KAPAĞI / LABYRINT PROFILE FOR PLUG KOLİ MİKTARI / PACKAGE QUANTITY: 500 ad		PVC
700 451	SU TAHLİYE KAPAĞI / WATER DRAINAGE CAP KOLİ MİKTARI / PACKAGE QUANTITY: 50 ad		PVC
700 475	AYARLI RULMAN / ADJUSTABLE ROLLER KOLİ MİKTARI / PACKAGE QUANTITY: 50 ad		
700 476	SABİT RULMAN / FIXED ROLLER KOLİ MİKTARI / PACKAGE QUANTITY: 50 ad		
700 473	KANAT STOPERİ / SASH STOPPER KOLİ MİKTARI / PACKAGE QUANTITY: 50 ad		PVC
ST L 1202	İSPANYOLET TİJ ÇUBUĞU/ CREMONE LOCKING DEVICE KOLİ MİKTARI / PACKAGE QUANTITY: 2 pieces		

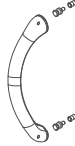
AKSESUAR KODU ACCESSORY CODE	MALZEME TANIMI DESCRIPTION	ÇİZİM DRAWING	MALZEME MATERIAL
700 477	ALT SIZDIRMAZLIK PARÇASI / BOTTOM EPDM TIGHTNESS PLUG KOLİ MİKTARI / PACKAGE QUANTITY: 50 ad		
ST A 3034 / 700 435	BUTONLU KÖŞE TAKOZU / BUTTON JOINT FOR FRAME KOLİ MİKTARI / PACKAGE QUANTITY: 50 ad (11x25 tüm kasa profilleri ile kullanılır)		ZAMAK
ST A 3033 / 700 436	BUTONLU KÖŞE TAKOZU / BUTTON JOINT FOR FRAME KOLİ MİKTARI / PACKAGE QUANTITY: 50 ad (11x19 tüm kasa profilleri ile kullanılır)		ZAMAK
700 356	KASA İÇİ ONBAŞI / CORNER CLEAT KOLİ MİKTARI / PACKAGE QUANTITY: 500 ad		ALÜMİNYUM ALUMINIUM
700 479	KÖŞE ONBAŞI / ALUMINUM CORNER ANGLE FOR SASH KOLİ MİKTARI / PACKAGE QUANTITY: 100 ad		ALÜMİNYUM ALUMINIUM
700 471	PVC İSPANYOLET KİLİT KARŞILIĞI / KEEPER FOR PVC ESPAGNOLETES KOLİ MİKTARI / PACKAGE QUANTITY: 50 ad		PVC
700 832	SAĞA KIVRIK KOL / HANDLE (RIGHT) KOLİ MİKTARI / PACKAGE QUANTITY: 20 ad		
700 832	SOLA KIVRIK KOL / HANDLE (LEFT) KOLİ MİKTARI / PACKAGE QUANTITY: 20 ad		
700 482	D KOL / HANDLE KOLİ MİKTARI / PACKAGE QUANTITY: 50 ad		

SARAY®

ST 91 PACKED PROFİLLERİ

ST 91 PACKED PROFILES

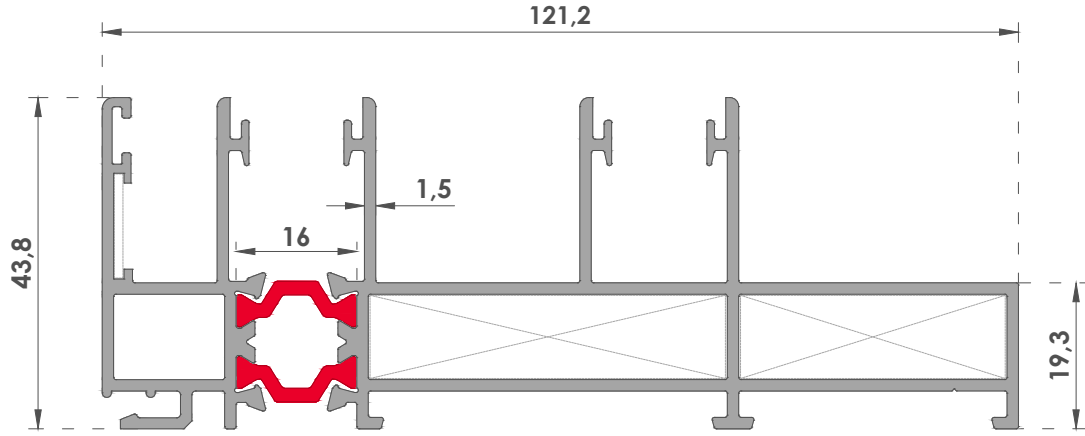

PRF 12025/12026

JX (cm ⁴)	I_y	JY (cm ⁴)
10,03	x	10,51

AĞIRLIK / WEIGHT
(KG/M.)
1,382

KÖŞE TAKOZLARI
CORNER CLEATS

TAKOZ 858 (45mm)
TAKOZ 858 (35mm)

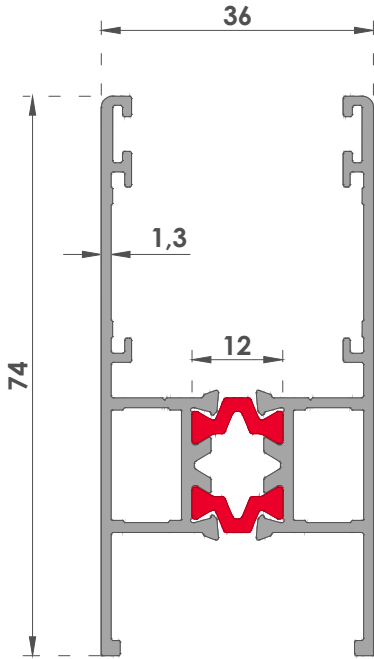

PRF P 1300

JX (cm ⁴)	I_y	JY (cm ⁴)
14,47	x	7,91

AĞIRLIK / WEIGHT
(KG/M.)
1,870

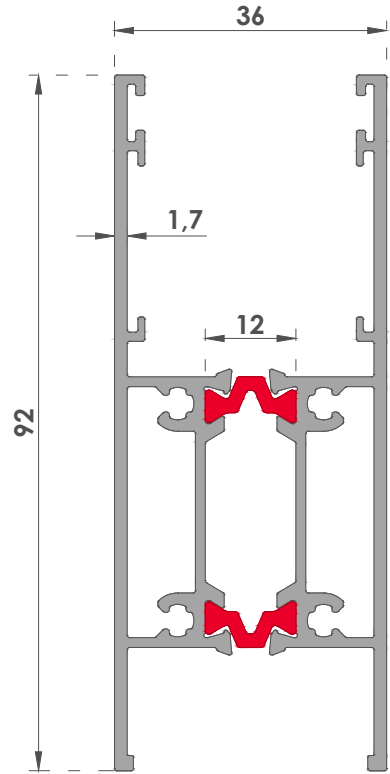

PRF P 1302

JX (cm ⁴)	I_y	JY (cm ⁴)
33,16	x	11,54

AĞIRLIK / WEIGHT
(KG/M.)
1,870

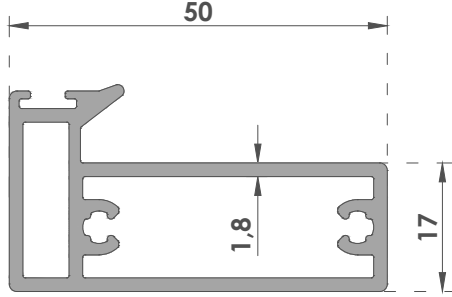

PRF 12028

AĞIRLIK / WEIGHT
(KG/M.)
0,907

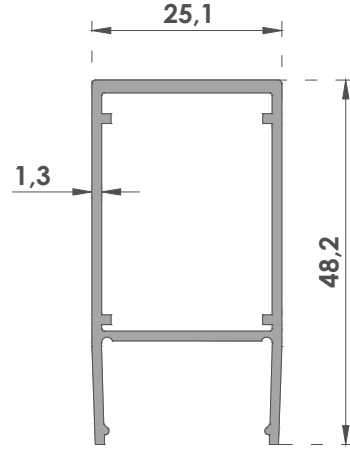

PRF 12032

AĞIRLIK / WEIGHT
(KG/M.)
0,536

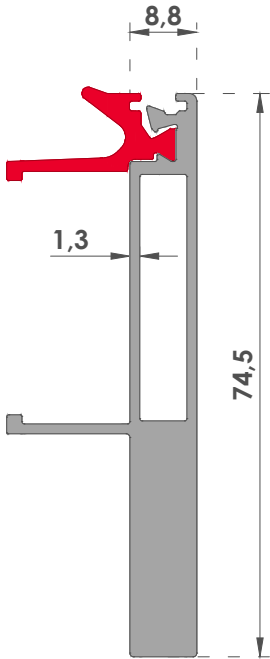

PRF 12029

AĞIRLIK / WEIGHT
(KG/M.)
1,166

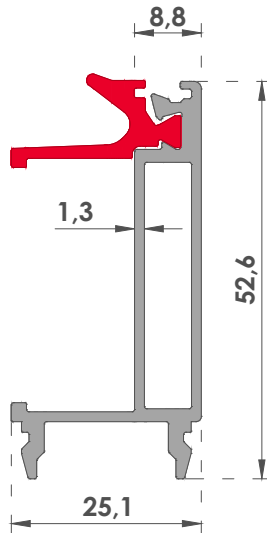

PRF 12030

AĞIRLIK / WEIGHT
(KG/M.)
0,549

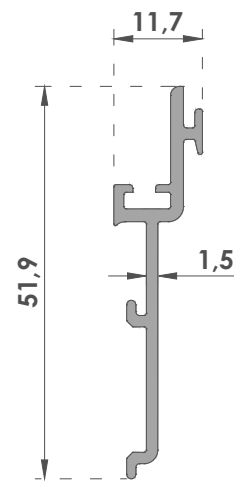

PRF 1314

AĞIRLIK / WEIGHT
(KG/M.)
0,316

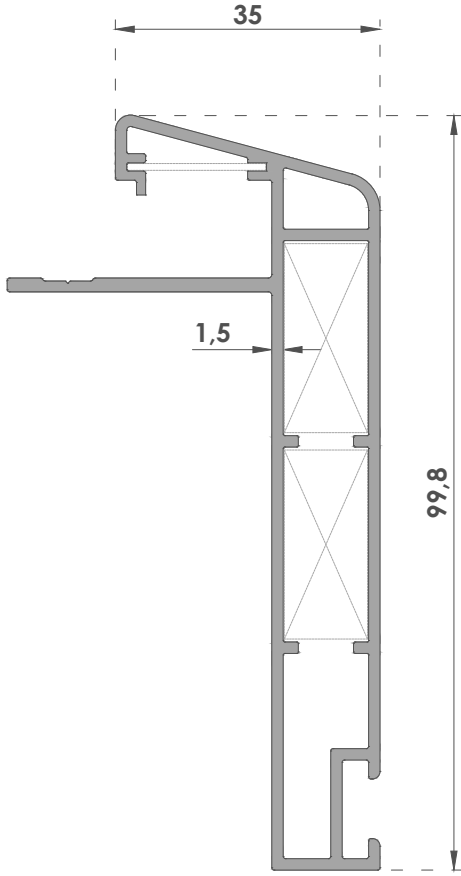

PRF 12042

AĞIRLIK / WEIGHT
(KG/M.)
1,279

KÖŞE TAKOZLARI
CORNER CLEATS
TAKOZ 700 435

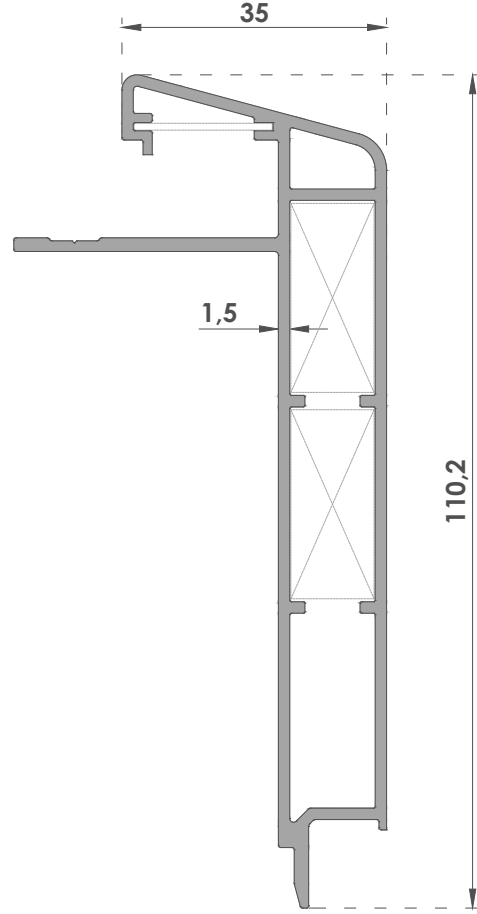

PRF 12031

AĞIRLIK / WEIGHT
(KG/M.)
1,301

KÖŞE TAKOZLARI
CORNER CLEATS
TAKOZ 700 435

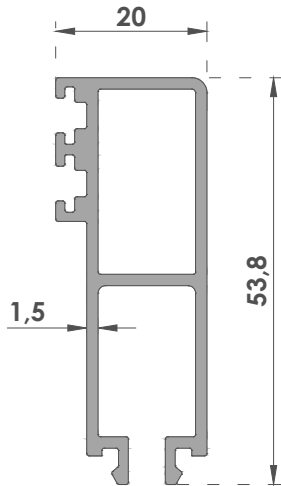

PRF 12033

AĞIRLIK / WEIGHT
(KG/M.)
0,683

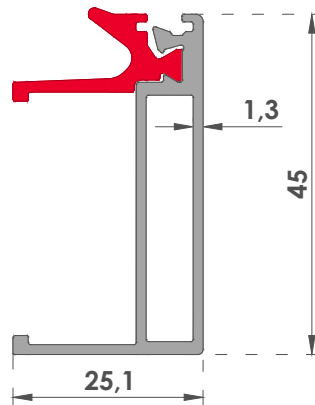

PRF-ST P 1031

AĞIRLIK / WEIGHT
(KG/M.)
0,563

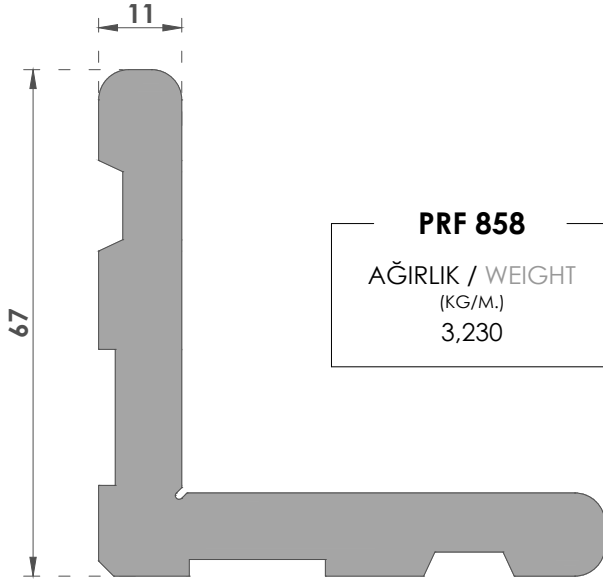

ST 91 PACKED DETAYLARI

ST 91 PACKED DETAILS

01
Detay-Detail

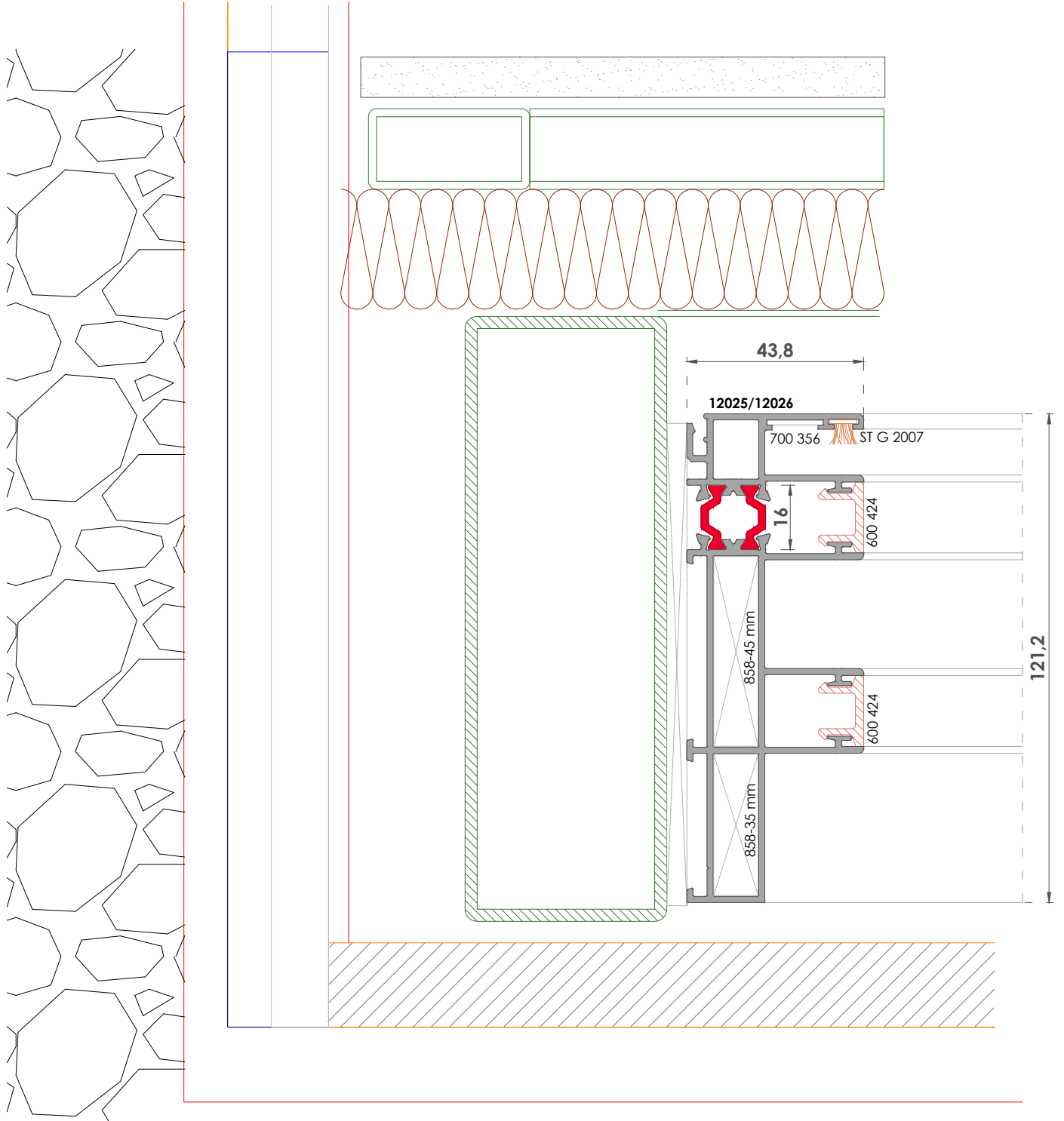
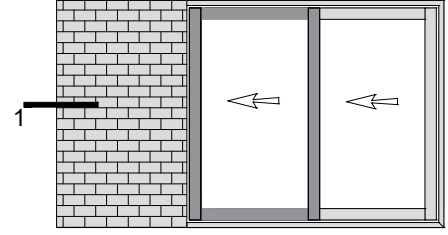

02
Detay-Detail

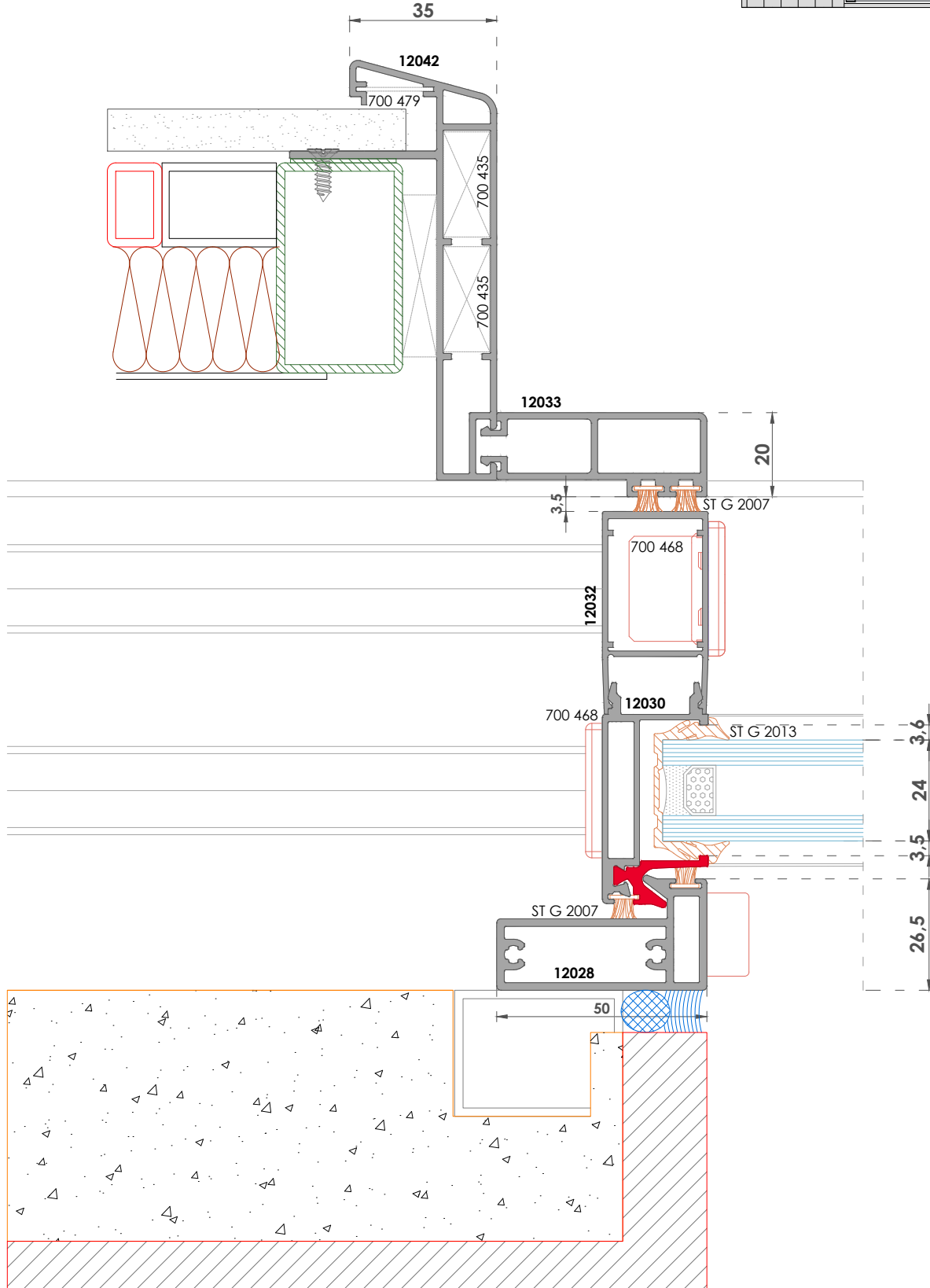
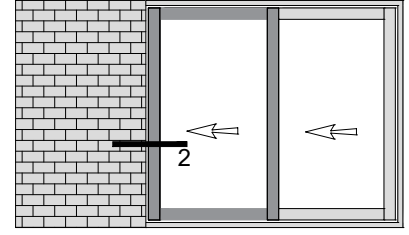

Sipariş miktarı minimum yalıtımlı profiller için 600 kg, yalıtımsız profiller için 300 kg dir. / Minimum order quantity ; insulated profile 600 kg, uninsulated profile 300 kg.
Uyarı: Profil ağırlıklarımız teorik olup ; teslim anındaki tartımlar geçerlidir. / Warning: The weights of profile is theoretical, weighting at the time of delivery are valid

03
Detay-Detail

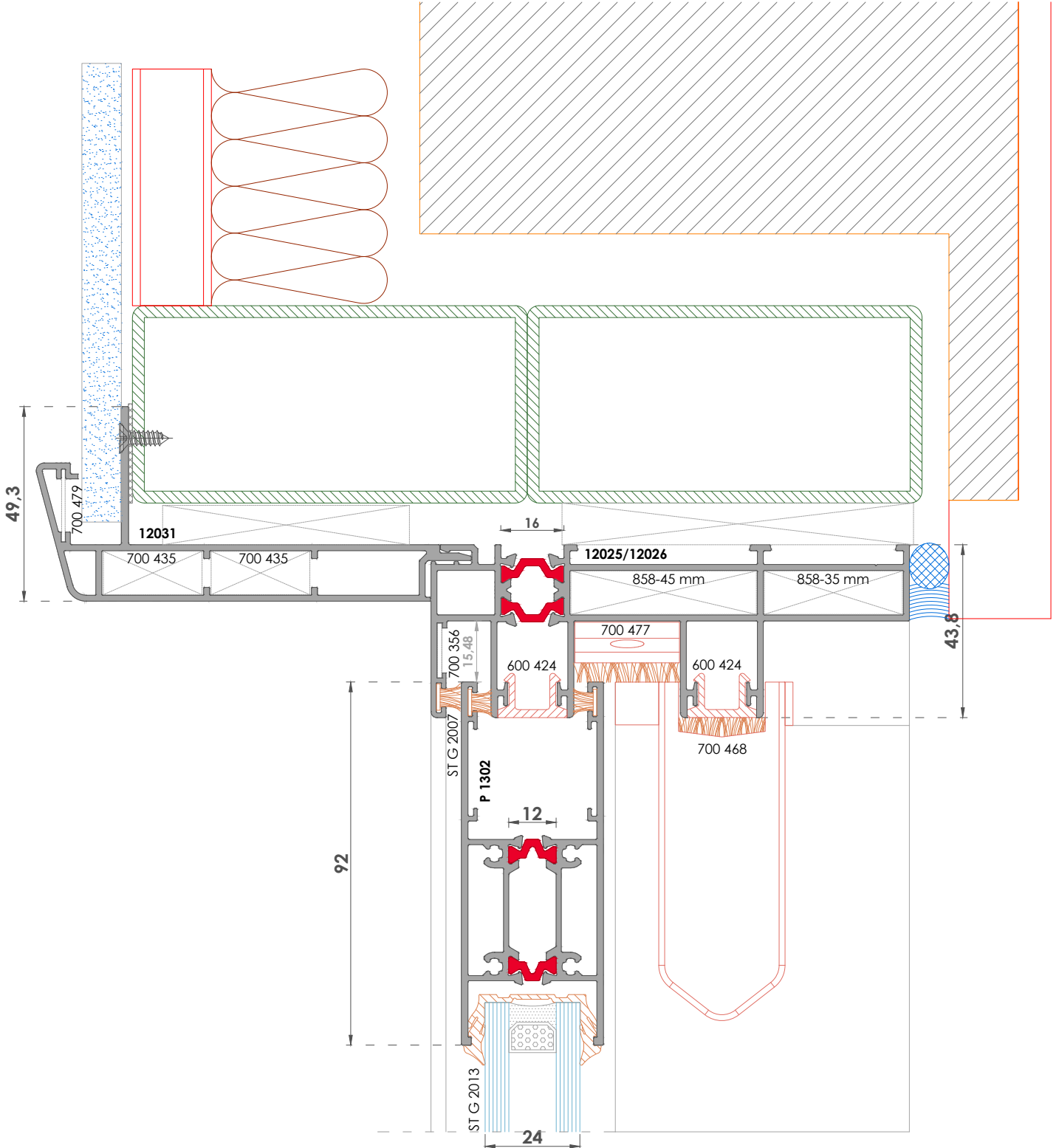
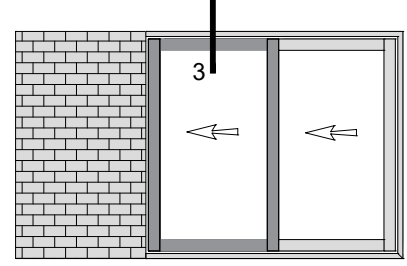

Sipariş miktarı minimum yalıtımlı profiller için 600 kg, yalıtımsız profiller için 300 kg dir. / Minimum order quantity ; insulated profile 600 kg, uninsulated profile 300 kg.
Uyarı: Profil ağırlıklarımız teorik olup ; teslim anındaki tartımız geçerlidir. / Warning: The weights of profile is theoretical, weighting at the time of delivery are valid

08
Detay-Detail

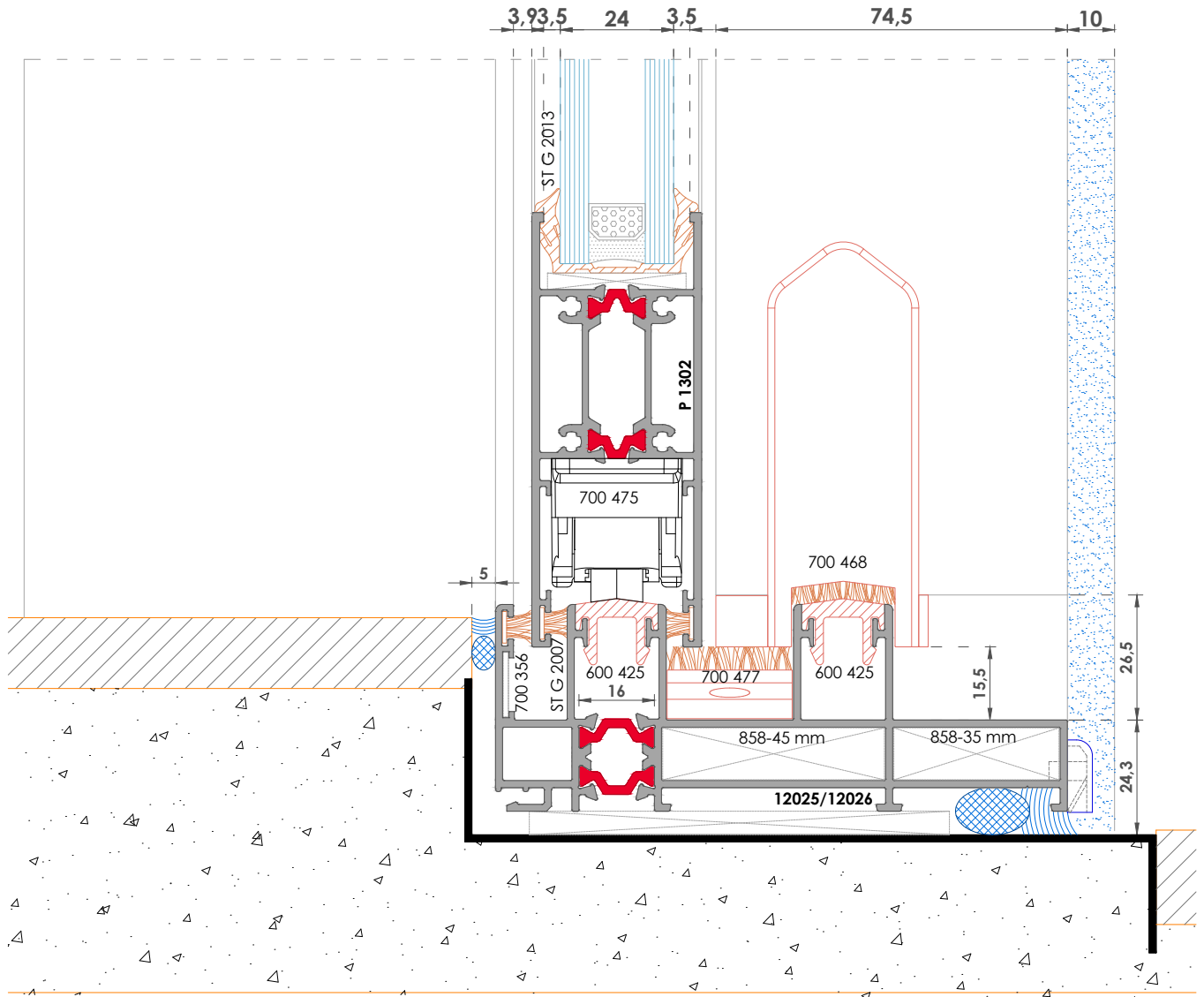
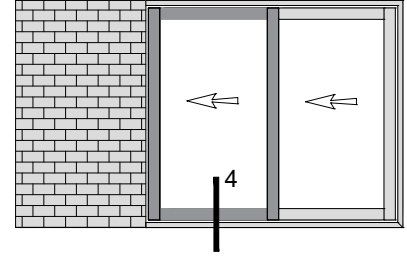

06
Detay-Detail

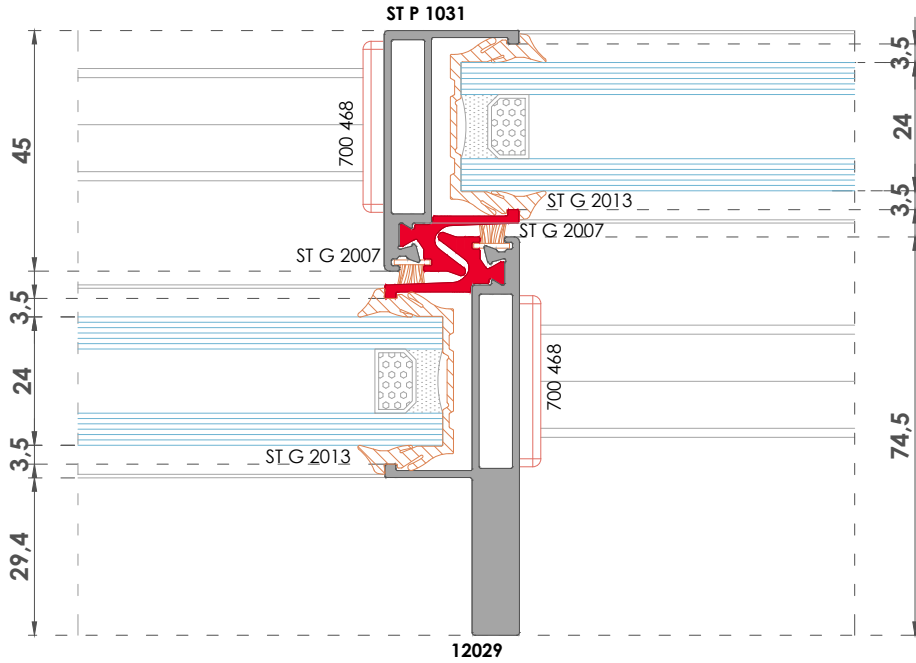
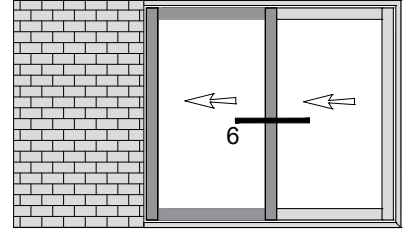

07
Detay-Detail

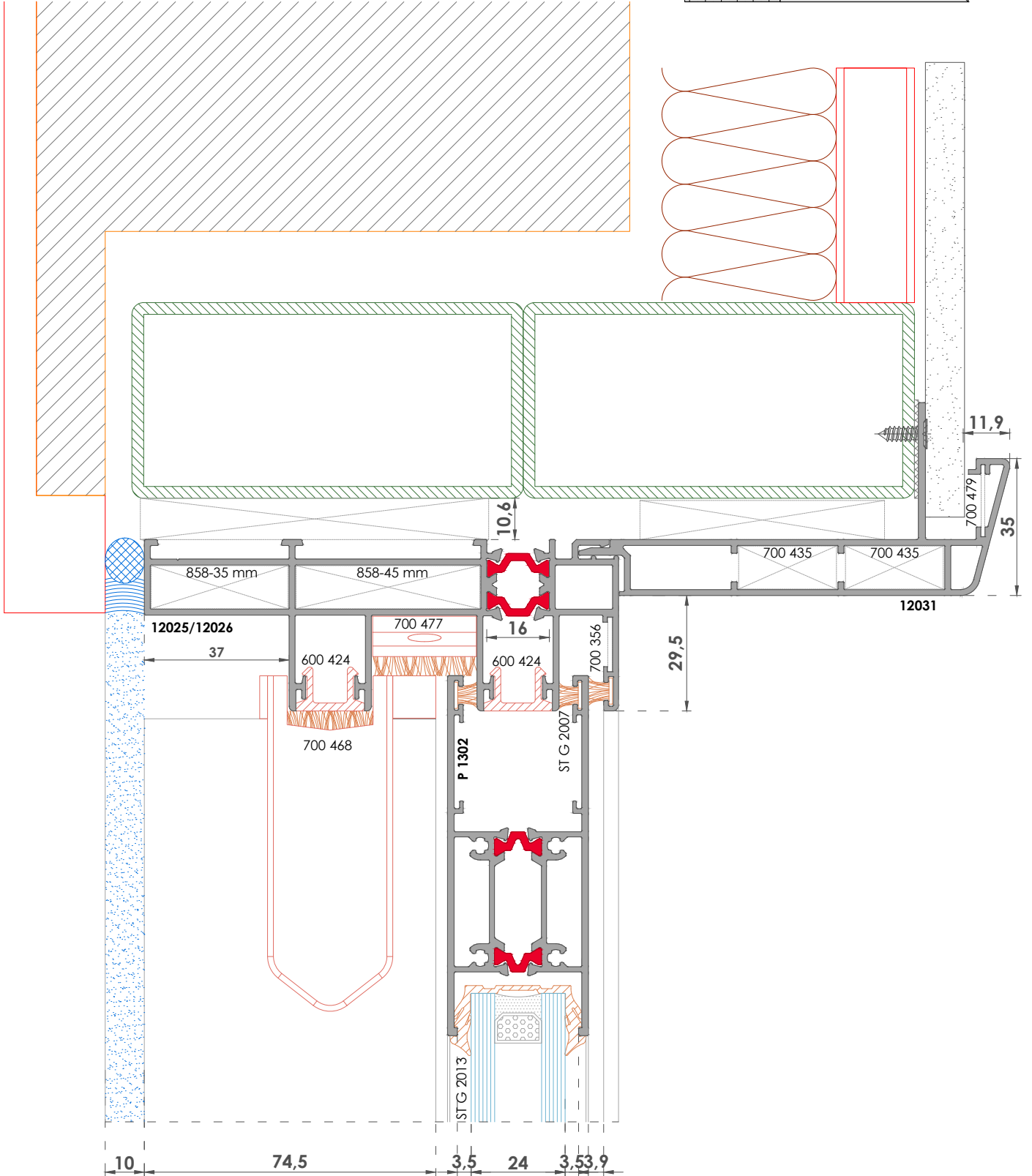
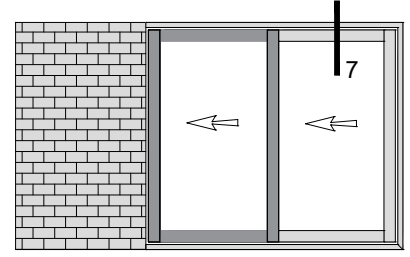

Sipariş miktarı minimum yalıtımlı profiller için 600 kg, yalıtımsız profiller için 300 kg dir. / Minimum order quantity ; insulated profile 600 kg, uninsulated profile 300 kg.
Uyarı: Profil ağırlıklarımız teorik olup ; teslim anındaki tartımız geçerlidir. / Warning: The weights of profile is theoretical, weighting at the time of delivery are valid

09
Detay-Detail

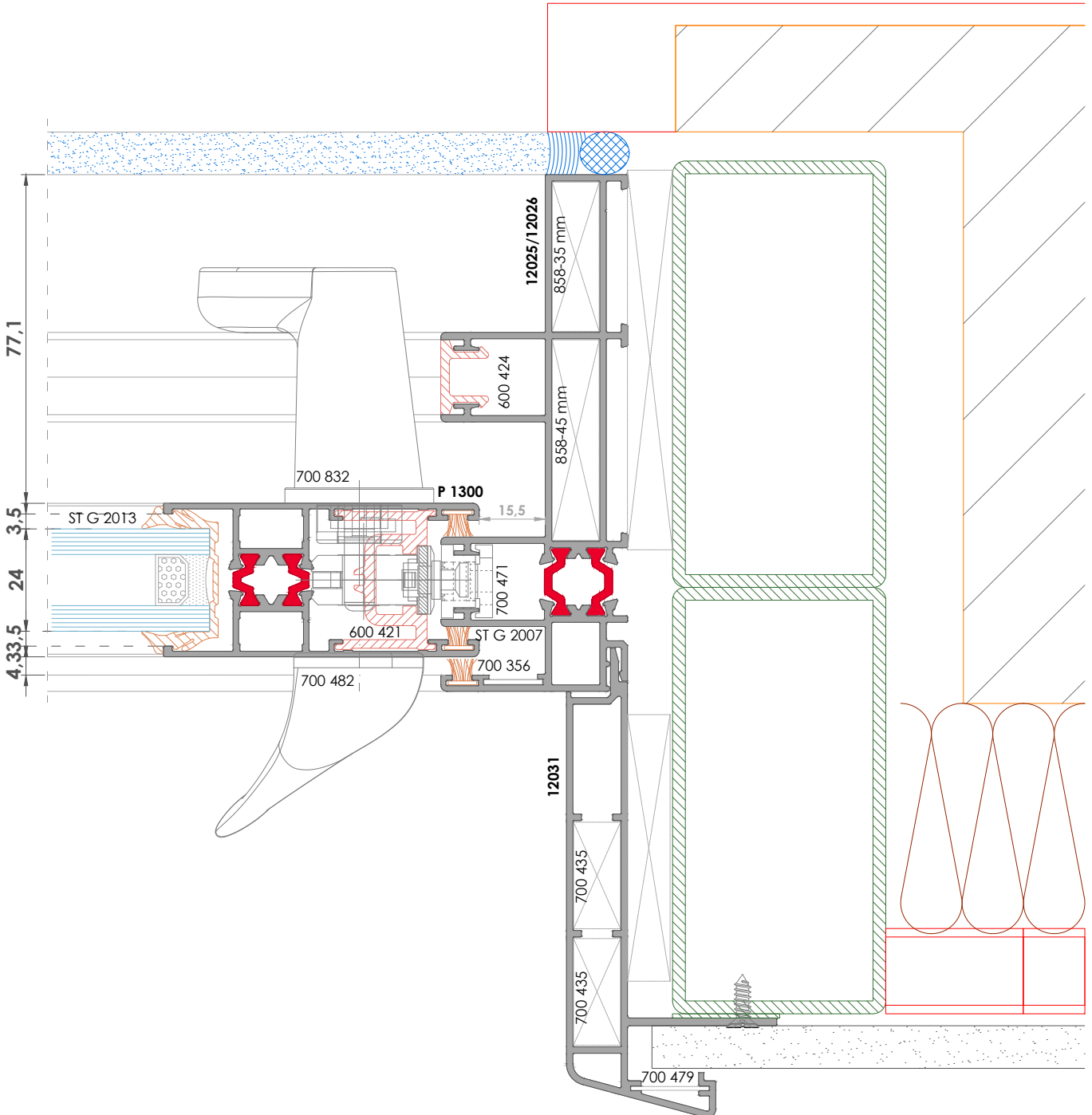
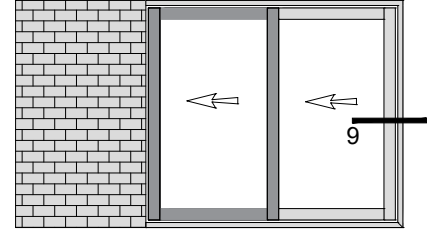

10
Detay-Detail

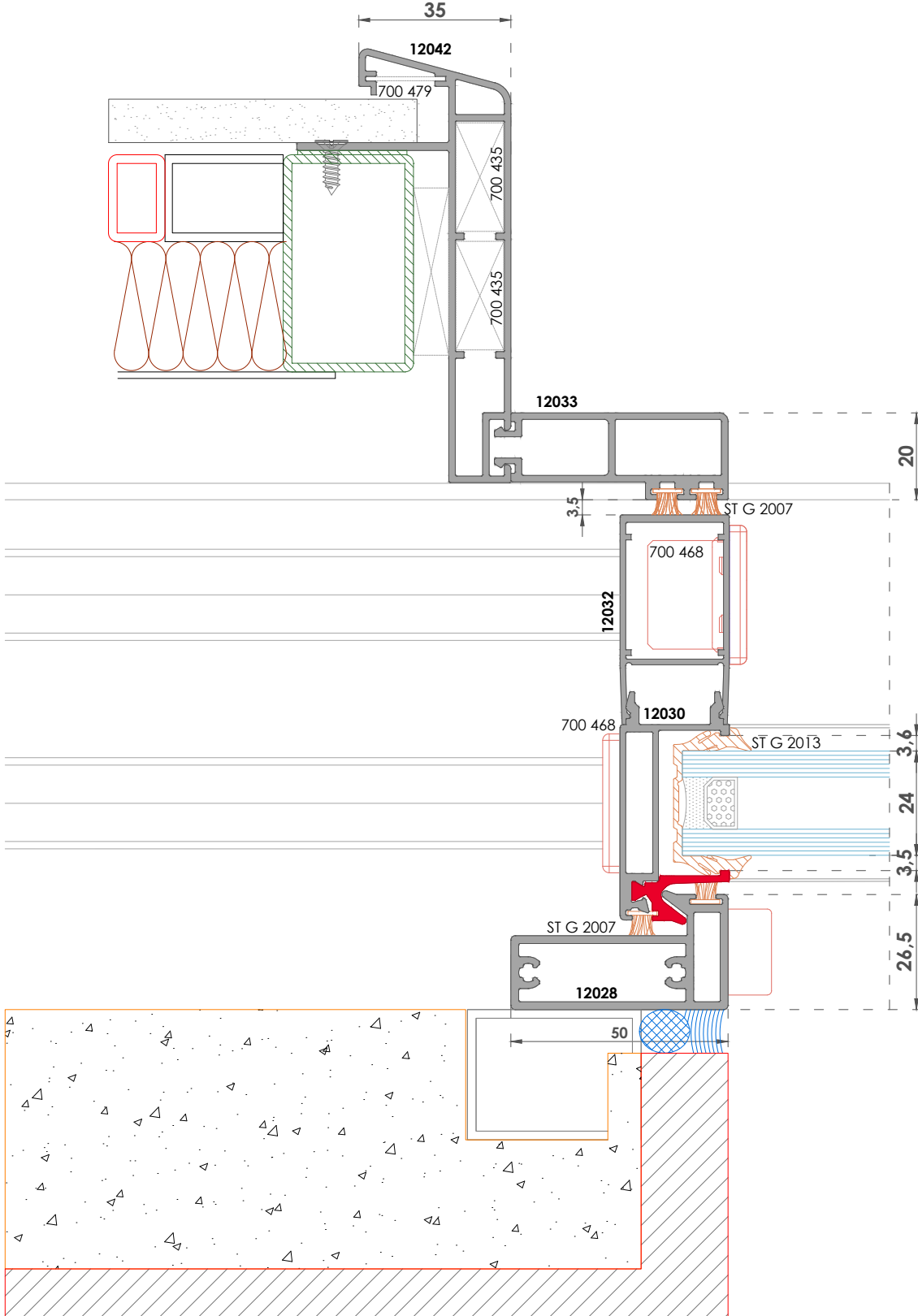
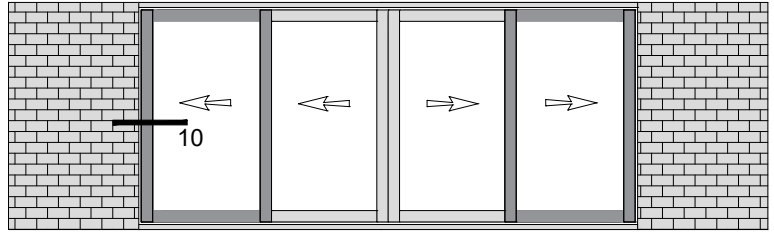

Sipariş miktarı minimum yalıtımlı profiller için 600 kg, yalıtımsız profiller için 300 kg dir. / Minimum order quantity ; insulated profile 600 kg, uninsulated profile 300 kg.
Uyarı: Profil ağırlıklarımız teorik olup ; teslim anındaki tartımız geçerlidir. / Warning: The weights of profile is theoretical, weighting at the time of delivery are valid

11
Detay-Detail

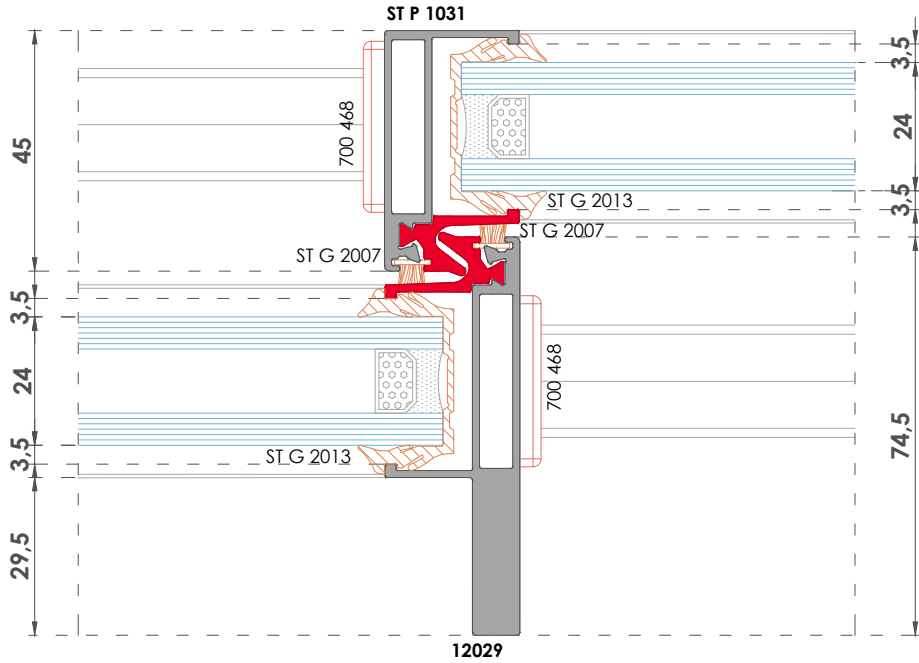
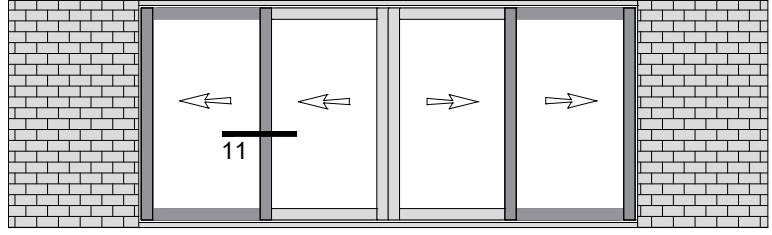

13
Detay-Detail

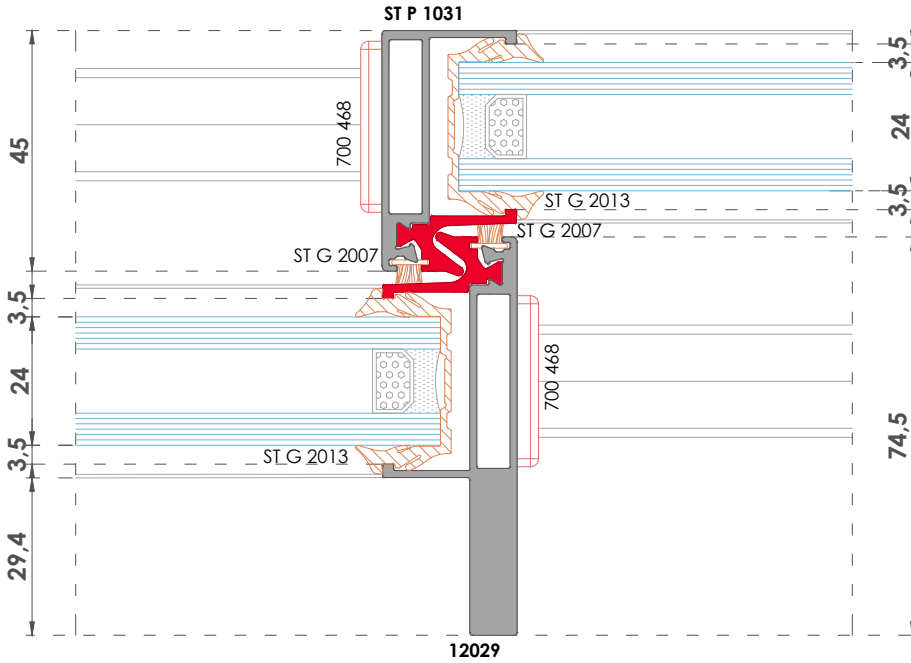
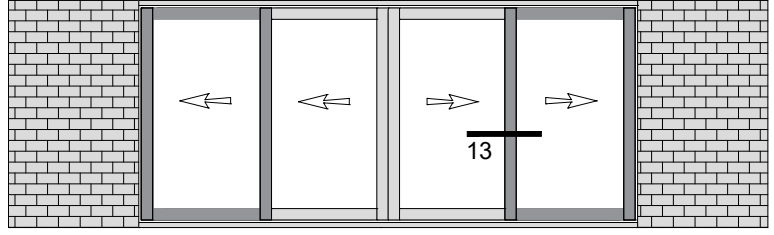

14
Detay-Detail

